



Product Brochure

SEWING MACHINE NEEDLES

ミシン針カタログ

缝纫机针目录



ORGAN NEEDLE CO., LTD.



主要寸法 / MAIN DIMENSIONS / 主要尺寸

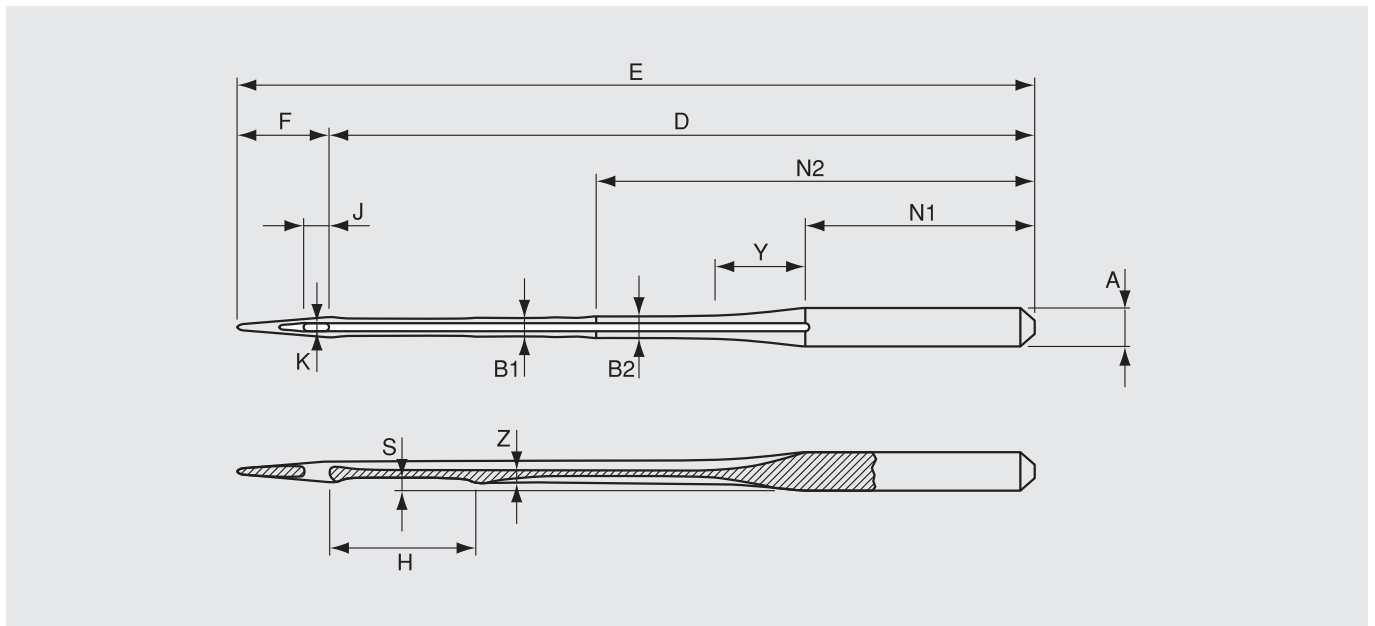

A	軸径	Shank diameter	针柄直径
B	幹径	Blade diameter	针杆直径
D	穴上寸法	Butt to eye length	针眼上部长度
E	全長	Total length	针全长
F	穴先寸法	Distance from end of eye to tip	针眼下部长度
S	えぐり深さ	Depth of scarf	针冠深

H	えぐり長さ	Length of scarf	针冠长度
J	穴縦寸法	Length of eye	针眼长度
K	穴横寸法	Width of eye	针眼宽度
N	軸寸法	Length of shank	针柄长度
Z	溝深さ	Depth of groove	针槽尺寸
Y	テーパー部寸法	Length of shank taper	圆锥部尺寸

主要部位名称 / ANATOMY OF NEEDLE / 各部名称

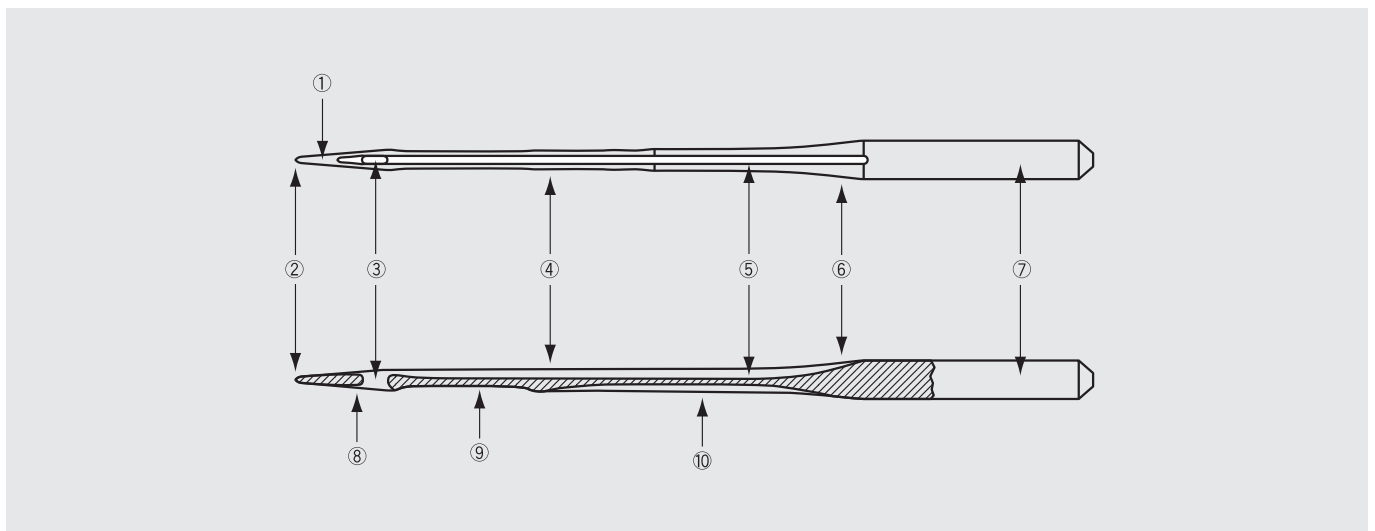

①	針先部	Needle point	针头
②	先端	Tip of the point	针尖
③	糸穴	Needle eye	针眼
④	針幹	Blade	针杆
⑤	表溝	Long groove	长针槽

⑥	テーパー部	Shank taper	圆锥部
⑦	軸	Shank	针柄
⑧	短溝	Point groove	短槽
⑨	えぐり	Scarf	针冠
⑩	裏溝	Short groove	短针槽

針と糸の関係表 / NEEDLE & THREAD / 针和线关系表

※ 参考資料としてお使いください。 This table is only for reference purposes. 请作为参考资料使用

フィラメント Filament 长纱线				
糸 Thread 线				針番手 Needle Size 针号
Japanese Ticket	Ticket	Nm	Tex	
100	250		10	55/7
80	230		12	55/7-65/9
60	200	180	16	55/7-70/10
50	120	160	24	60/8-80/12
40	80	100	30	70/10-100/16
30	60		50	80/12-110/18
20	40	40	60	90/14-125/20
10	30	30	80	100/16-130/21
8	25	25	105	110/18-140/22
5	20		180	130/21-180/24

コアスパン Core Spun 包芯纱				
糸 Thread 线				針番手 Needle Size 针号
Japanese Ticket	Ticket	Nm	Tex	
60	180	160	18	60/8-65/9
	150	150	21	60/8-70/10
50	120	120	24	70/10-80/12
	100	100	30	70/10-90/14
	80	75	40	80/12-100/16
		60	50	90/14-100/18
30	50	50	60	90/14-120/19
	40	36	80	100/16-120/19
20	30	30	105	100/16-140/22
8	25	25	140	120/19-160/23
5		14	200	140/22-160/23

スパン Spun 斯潘线				
糸 Thread 线				針番手 Needle Size 针号
Japanese Ticket	Ticket	Nm	Tex	
120	200	200	16	50/6-55/7
90	180	180	18	55/7-65/9
80(2-twist)	150	140	21	60/8-80/12
80(3-twist)	140	140	21	60/8-80/12
60(2-twist)	120	120	27	65/9-90/14
60(3-twist)	110	120	27	65/9-90/14
50(2-twist)	90	120	30	70/10-100/16
50(3-twist)	80	75	40	70/10-100/16
40	75	75	40	80/12-110/18
30(2-twist)	50	50	60	90/14-120/19
30(3-twist)	60	50	70	90/14-120/19
20	30		80	100/16-125/20
10	25	30	105	110/18-130/21
8	24	25	120	120/19-160/23

刺繍糸 Embroidery Thread 刺繍线	
Denir	針番手 Needle Size 针号
75	60/8-70/10
120	65/9-75/11
200	75/11-90/14

呼び番手(日本) Japanese Ticket	針番手 Needle Size 针号			
	綿糸 Cotton 棉纱	ポリエステル スパン Polyester spun 涤纶短纱	ポリエステル フィラメント Polyester filament 涤纶长纱	ナイロン フィラメント Nylon filament 尼龙线
120	7	7		
100	7-8	7-8	7	7-9
80	7-11	7-9	7-9	7-10
60	8-14	8-12	7-10	7-11
50	10-16	10-14	8-12	9-14
40	14-19	12-18	11-16	11-14
30	16-21	14-19	14-20	16-19
20	19-23	19-23	18-22	18-21
10	20-23	20-23	19-23	
8	22-24	22-24	19-24	
5			24-25	

シリーズ・先端・針先・表面処理
 SERIES・NEEDLE POINT・COATING
 系列・针头・针尖・表面处理

シリーズ / Series / 系列

厚手素材や重ね枚数が多いときに
 For Thick and/or Multi-layered Fabrics
 厚重面料、重叠层数多的时候

KK series

- 短い軸形状
Short shank
短轴形状

安定したループ形成
 For Stable Loop Formation
 形成稳定的线圈

NY2 series

- ロングテーパー形状
Long tapered shape
长锥型形状
- クリフスカーフ
Cliff scarf
船型针冠
- スリムな針先形状
Slim needle point
纤细的针尖形状

目飛びするときに
 For Skipped Stitches
 发生跳线时

SK series

- クランクスカーフ形状
Crank scarf
船型针冠形状

繊細な素材に
 For Delicate Fabrics
 用于纤细素材

KN/SF series

- Sポイント
S point
S圆头
- ストレート幹形状
Straight blade
直线型针杆

極薄素材に
 For Ultra Thin Fabrics
 用于极薄面料

NS series

- SPIポイント
SPI point
SPI尖头
- 先端テーパー形状
Long tapered needle point
长锥型针头
- ストレート幹形状
Straight blade
直线型针杆

樹脂素材に
 For Resin Materials
 用于树脂面料

RS series

- 特殊針先形状
Specially designed needle point
特殊针尖形状
- ※ DP×17のみ展開
Applicable only on DP×17
仅限于DP×17



表面处理 / Coating / 表面处理

摩耗をおさえる
 For Extra Durability
 抑制磨损

PD coating



- 高硬度の表面处理
Titanium coating
高硬度表面处理

粘着(芯地・接着剤)に強い
 For Anti-adhesion
 有效防止粘着(芯布・接着剤)

LP coating



- 非粘着性の高い表面处理
Anti-adhesive coating
非粘着性较高的表面处理

針熱が上がりやすいときに
 For Heat Resistance
 容易发生针热时

HP coating



- 放熱しやすい表面处理
Heat release coating
容易放热的表面处理

一部製品を除く全ての工業用ミシン針に加工可能
 Applies to almost all industrial sewing machine needles
 部分产品除外, 几乎所有的工业用缝纫机针都能加工

先端・針先 / Needle Point / 针头・针尖

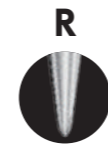

R
 正規型
 Regular point
 标准针头



TRI
 小三角型
 Light triangular point
 小三角型针头



SPI
 尖頭細身型
 Slim sharp point
 尖头细身型针头

HO	HR	CR	CL	ER	EL	EK	EM

単系に合わせるボール
 Selections for a Variety of Knitted Fabrics
 适合纱线的圆头

BP series

S point



一般的なニット等
 For general knits
 一般的针织物等

当社オリジナル小ボール
 ORGAN original: slim & small ball
 我公司特有小圆头

B ball



比較的粗いニット等
 For coarse knits
 较粗犷的针织面料等

中ボール
 Medium size
 中圆头

U ball



婦人用ファンデーション
 パワーネット等
 Elastic knits for under
 garments
 女性内衣用网眼面料等

大ボール
 Large size
 大圆头

Y ball



編目が粗い特殊ニット等
 For extra coarse knits
 孔眼较大的特殊针织布等

特大ボール
 Extra large size
 特大圆头

一部製品を除く全ての工業用ミシン針に加工可能
 Applies to almost all industrial sewing machine needles
 部分产品除外, 几乎所有的工业用缝纫机针都能加工

トラブル解決 / TROUBLESHOOTING / 縫制問題解決

















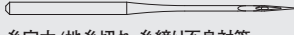



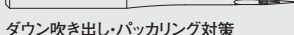



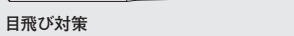

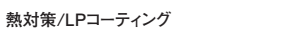



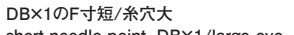

トラブル Trouble 縫制問題	素材 Material 面料	原因 / Cause / 原因			対策 / Countermeasure / 対策			対策針 Countermeasure Needle 対策針
地糸切れ Fabric Yarn Breakage 面料断线	ニット・布帛 Knit-Cloth 针织布・机织布	針先端の潰れ・変形	Crushed and/or deformed needle point	針尖破損・変形	ボールポイントを使う Use appropriate ball-point	使用圆头针	BP series	
					硬度の高い表面処理にする Use coated needle with high durability	用硬度较高的表面处理	PD coating	
		針の太さで切断する	Needle size is too big	針太粗导致切断	ミシン速度を下げる Reduce sewing speed	降低缝纫机速度		
					針番手を下げる Reduce needle size	降低针号		
	布帛 Cloth 机织布	針の太さで切断する	Needle size is too big	針太粗导致切断	貫通抵抗の低い細身の針を使う Use slim needle to reduce penetration resistance	使用贯穿抵抗较低的细针	NS series	
				生地にしリコンスプレーを塗布する Spray silicon on fabrics	给面料喷硅胶			
	ニット Knit 针织布	針の先端と太さで切断する	Inappropriate point style / Needle too big	针头和针太粗导致切断	細身でボールポイントの針を使う Use slim needle with ball-point	使用细身圆头针	KN/SF series	
	ニット・布帛 Knit-Cloth 针织布・机织布	熱で切断する	Fabrics are damaged by heat	针热导致切断	針熱を下げる Reduce needle heat	降低针热	HP coating	
					生地にしリコンスプレーを塗布する Spray silicon on fabrics	给面料喷硅胶		
					針番手を下げる Reduce needle size	降低针号		
ミシン速度を下げる Reduce sewing speed					降低缝纫机速度			
ニードルクーラーを使う Use needle cooler					使用针冷却装置			
生地への加湿 Humidify fabrics					给面料加湿			
生地が乾燥して切れやすい Fabric is damaged by dried fabric					面料干燥容易切断	生地への加湿 Humidify fabrics	给面料加湿	
針の先端で切断する	Sharp needle point cuts fabrics	针头导致切断	ボールポイントを使う Use appropriate ball-point	使用圆头针	BP series			
針のテーパーパー部が生地に刺さる	Taper of needle penetrates into fabrics	针的锥形部分进入面料	軸の短い針を使う Use short shank needle	使用针柄短的针	KK series			
目飛び Skipped Stitches 跳线		針振れ・ループが不安定	Needle vibration/ Poor loop formation	针晃动・线圈不稳定	強度を上げる・ループ形成の良い針を使う Increase needle strength / Use needle with stable loop formation	提高强度・使用形成良好线圈的针	SK series	
					ミシン速度を下げる Reduce sewing speed	降低缝纫机速度		
					針番手を上げる Raise to larger needle size	提高针号		
バックリング Puckering 縫迹收缩		針先端の潰れ・変形	Crushed and/or deformed needle point	針尖破損・変形	硬度の高い表面処理にする Use coated needle with high durability	用硬度较高的表面处理	PD coating	
					鋭い先端で細身の針を使う Use slim and sharp needle point	使用尖头细身的针	NS series	
		生地の上下動による	Fabric flops	面料上下抖动	針番手を下げる Reduce needle size	降低针号		
					鋭利な先端SPIを使う Use sharp SPI point	使用尖头SPI的针		
					テープ/芯を使う Use tape or interlining	使用胶带/衬布		
					ミシン速度を下げる Reduce sewing speed	降低缝纫机速度		
					糸張力を弱くする Reduce thread tension	降低缝线张力		
					細い糸を使う Use thinner thread	使用细线		
					摩擦の低い表面処理にする Use coated needle for less friction	用摩擦系数较小的表面处理	LP coating	
					針板の穴が小さいものを使う Use needle plate with smaller hole	使用眼较小的针板		
生地への加湿 Humidify fabrics	给面料加湿							
ダウンの吹き出し Down Migration 羽绒面料跑绒	布帛 Cloth 机织布	針穴跡からダウンが吹き出す Inside down comes out from needle mark	针脚处跑绒	細身の針を使う Use slim needle	使用细针	NS series		
	ニット Knit 针织布	地糸切れした穴から吹き出す Inside down comes out from yarn breakage hole	从面料断线处跑绒	細身の針を使う Use slim needle	使用细针	KN/SF series		
		針穴跡からダウンが吹き出す Inside down comes out from needle mark	针脚处跑绒	摩擦の低い表面処理にする Use coated needle for less friction	用摩擦系数较小的表面处理	LP coating		
				ダウンの吹き出し防止糸を使う Use special thread for preventing down migration	使用防止跑绒的缝线			
				摩擦の低い表面処理にする Use coated needle for less friction	用摩擦系数较小的表面处理	LP coating		
	地糸切れした穴から吹き出す Inside down comes out from yarn breakage hole	从面料断线处跑绒	ダウンの吹き出し防止糸を使う Use special thread for preventing down migration	使用防止跑绒的缝线				

トラブル Trouble 縫制問題	素材 Material 面料	原因 / Cause / 原因		対策 / Countermeasure / 対策			対策針 Countermeasure Needle 対策針		
半掛け Half Pick-up 劈線	ウーリー糸 Woolly Thread 弾力糸	ループが小さいため ルーバーで引っ掛ける	Poor loop formation	线圈较小导致弯针挂线	深いえぐりの針を使う	Use needle with deep scarf	使用针冠较深的针	SK series	
		ループが小さいため ルーバーで引っ掛ける	Poor loop formation	线圈较小导致弯针挂线	ミシン速度を下げる	Reduce sewing speed	降低缝纫机速度		
		ヒッチステッチバック 縫いででの燃り戻り	Thread twists during hitch stitch / back stitch	斜縫・倒縫時の退捻	えぐりが深く、ループ形 成のよい針を使う	Use needle with deep scarf and stable loop formation	使用针冠较深、线圈 形成良好的针	SK series	
		糸と針との不適合	Mismatch thread and needle	线和针不匹配	糸に適切な針番手を 選定する	Select appropriate needle size for thread	选择和线匹配的针号		
		燃り戻り	Twisted thread	退捻	針番手を上げる	Raise to larger needle size	提高针号		
突き出し Protrusion 顶出	ゴム Rubber 橡筋	針先端がゴムに刺さ る	Needle point pushes out rubber	针尖刺入橡筋	ゴムに適した大きさの ボールポイントを使う	Use appropriate ball-point	使用圆头针	BP series	
	ラメ糸 Metallic Thread 金银丝	針先端がラメ糸を押し 出す	Needle point pushes out metallic yarn	针尖将金银丝挤出	ゴムの一部を切断す ることで突き出しを防ぐ	Cut rubber with sharp needle point	切断部分橡筋从而防 止被顶出	NS series	
	ネップ(織り糸の太い箇所) Nep (Thick part on woven yarn) 结 (纱线上较粗的部分)	針先端が織り糸に刺さ る	Needle point pushes out woven yarn	针尖刺入纱线	針番手を下げる	Reduce needle size	降低针号		
針折れ Needle Breakage 断针	皮革+樹脂 Leather + Resin 皮革+树脂	樹脂パーツ上で針先 端が滑る	Needle point slips on resin material	针尖在树脂部分打滑	カッティングポイント を使う	Use cutting point	使用刀针	CUT series	
		針振れ	Needle vibration	针晃	針番手を上げる	Raise to larger needle size	提高针号		
		樹脂パーツ上で針先 端が滑る	Needle point slips on resin material	针尖在树脂部分打滑	強度を上げる	Increase needle strength	提高强度	SK series	
		針先端の潰れ・変形 による貫通力の低下	Poor penetration into fabric due to crushed and/or deformed needle point	针尖破损・変形导致 贯穿孔力降低	鋭い針先(レギュ ラーポイント)を使う	Use sharp needle point (standard point)	使用尖头的针 (标准针尖)		
糸引け Yarn Pulling 抽丝	織り密度の低い素材 Coarse Woven Fabric 密度較低的面料	糸や針で織り糸を寄せ る	Loose woven yarn with thread and/or needle	线和针导致纱线移动	針番手を下げる	Reduce needle size	降低针号		
					細身の針を使う	Use slim needle	使用细针	NS series	
					糸張力を弱くする	Reduce thread tension	降低縫線张力		
		針が刺さって、織り糸 が加燃される	Needle pushes and twists woven yarn	针刺入面料导致纱线 加捻	細い糸を使う	Use thinner thread	使用细线		
					縫いピッチを細かくする	Reduce stitch length	减小针距		
					テープ/芯を使う	Use tape or interlining	使用胶带/衬布		
糸返り Yarn Twisting 露白	プリント素材 Printed Fabric 印花面料	針先端で織り糸をひっ くり返す	Woven yarn is twisted	针尖带动纱线反转	ボールポイントを使う	Use appropriate ball-point	使用圆头针	BP series	
					細身でボールポイント の針を使う	Use slim needle with ball-point	使用细身圆头针	KN/SF series	
					細い糸を使う	Use thinner thread	使用细线		
					糸へのオイルング	Put oil on thread	给缝线上油		
					テープ/芯を使う	Use tape or interlining	使用胶带/衬布		
柄ずれ Mismatched Fabric Pattern 花纹紊乱	プリント素材 Printed Fabric 印花面料	針先端が刺さって、織 り糸を押し出す	Needle point pushes out woven yarn	针尖刺入纱线并将其 带出	織り糸に刺さらない大き さのボールポイントを使う	Use appropriate ball-point	使用圆头以防刺入纱 线	BP series	
					ミシン速度を下げる	Reduce sewing speed	降低缝纫机速度		
	キュプラ・フィラメント織物 Cupro / Filament Woven Fabric 人造丝・涤纶面料					生地への加湿	Humidify fabrics	给面料加湿	
						細身の針を使う	Use slim needle	使用细针	NS series
					細い糸を使う	Use thinner thread	使用细线		

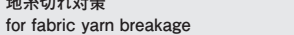
記号 SYSTEM 记号	他社記号 OTHER BRANDS SYSTEM 其他公司记号	先端 POINT 针头	針図 ILLUSTRATION 针图	用途・特徴 Application/Feature 用途・特征	番手 NEEDLE SIZE 针号
--------------------	---------------------------------------	-------------------	--------------------------	---------------------------------------	-------------------------

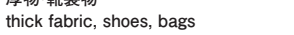
本縫い Lockstitch 平縫

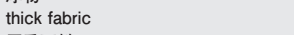
1本針/2本針本縫い 1-Needle/2-Needle Lockstitch 单针/双针平缝

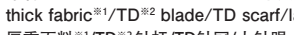
DBX1	1738 16X231 16X257 SY1515 SY2254		 1本針本縫い 1-needle lockstitch 单针平缝机	A : 1.63 / 1.91 / 2.03 D : 33.80 N : 16.00-10.50	7 8 9 10 11 12 13 14 16 18 / 19 / 20 55 60 65 70 75 80 85 90 100 110 / 120 / 125 21 22 22½ 23 24 25 130 140 150 160 180 200
NEW STANDARD DBX1++	1738 16X231 16X257 SY1515 SY2254		 TD*2 ブレード/TDスカーフ/糸穴大 TD*2 blade/TDscarf/large eye TD*2 针杆/TD针冠/大针眼	A : 1.63 D : 33.80 N : 16.50	7 8 9 10 11 12 13 14 16 18 55 60 65 70 75 80 85 90 100 110
DBX1KN			 地糸切れ対策 for fabric yarn breakage 面料断线对策	A : 1.63 D : 33.80 N : 16.00	8 9 10 11 12 14 60 65 70 75 80 90
DBX1KNLE			 糸穴大/地糸切れ・糸締め不良対策 large eye/for fabric yarn breakage, loose stitch 大针眼/面料断线・缝线不良对策	A : 1.63 D : 33.80 N : 16.00	9 10 11 12 65 70 75 80
DBX1SF			 地糸切れ対策 for fabric yarn breakage 面料断线对策	A : 1.63 D : 33.80 N : 16.00	8 9 10 11 60 65 70 75
DBX1NS			 ダウン吹き出し・パッカリング対策 for down migration, puckering 羽绒面料跑绒・缝迹收缩对策	A : 1.63 D : 33.80 N : 16.00	8 9 10 11 12 14 60 65 70 75 80 90
DBX1KK			 DBX1のN寸短 short shank, DBX1 DBX1的短柄针	A : 1.63 D : 33.80 N : 12.50	11 14 16 75 90 100
DBX1-NY2			 目飛び対策 for skipped stitches 跳线对策	A : 1.63 / 1.91 D : 33.80 N : 16.00-12.50	9 10 11 12 14 16 18 / 19 65 70 75 80 90 100 110 / 120
DBX1HS			 熱対策/LPコーティング heat resistance/LP coating 针热对策/LP涂层	A : 1.63 / 1.91 / 2.03 D : 33.80 N : 16.00-10.50	9 11 14 16 18 / 19 / 21 22 23 65 75 90 100 110 / 120 / 130 140 160
DBXA20	16X95 71X1 287WH SY6633		 A寸1.63mm shank diameter 1.63mm A寸1.63mm	A : 1.63 D : 33.80 N : 12.50-10.50	19 20 21 22 23 120 125 130 140 160
DBX287WKH	287WK 287WKH SY6633 SY6634		 DBX1のF寸短/糸穴大 short needle point, DBX1/large eye DBX1的短头针/大针眼	A : 1.63 D : 33.90 N : 16.00	7 8 9 10 11 12 13 14 16 18 19 21 55 60 65 70 75 80 85 90 100 110 120 130
DBX95	SY1515 16X5 16X95 71X1 287WH		 DBX1の一段伸線 single step reinforced blade, DBX1 DBX1の一段伸线	A : 1.63 D : 33.80 N : 13.50	8 9 10 11 12 13 14 16 17 18 19 20 60 65 70 75 80 85 90 100 105 110 120 125 21 22 23 130 140 160
DAx1	1128 88X1 88X9 SY1315 SY1361		 1本針本縫い 1-needle lockstitch 单针平缝机	A : 1.63 D : 29.60 N : 14.50	7 8 9 10 11 12 13 14 16 18 19 20 55 60 65 70 75 80 85 90 100 110 120 125 21 22 130 140
DAx1KN			 地糸切れ対策 for fabric yarn breakage 面料断线对策	A : 1.63 D : 29.60 N : 13.50	8 9 10 11 60 65 70 75
DIx3	29X1 29X3 332 SY3741		 厚物・靴袋物 thick fabric, shoes, bags 厚重面料・鞋・袋	A : 2.00 D : 39.20 N : 14.50	12 14 16 18 19 20 21 22 22½ 80 90 100 110 120 125 130 140 150 23 24 25 160 180 200
DPx17	135X17 2167 SY3355		 厚物 thick fabric 厚重面料	A : 2.00 D : 39.00 N : 16.00-13.00	9 10 11 12 13 14 16 18 19 20 21 65 70 75 80 85 90 100 110 120 125 130 22 23 24 25 26 140 160 180 200 230
NEW STANDARD DPx17++	135X17 2167 SY3355		 厚物*1/TD*2 ブレード/TDスカーフ/糸穴大 thick fabric*1/TD*2 blade/TD scarf/large eye 厚重面料*1/TD*2 针杆/TD针冠/大针眼	A : 2.00 D : 39.00 N : 16.00-13.50	9 10 11 12 13 14 16 18 19 20 21 22 65 70 75 80 85 90 100 110 120 125 130 140 23 24 160 180

※1 : ボタン付け/門止めにも対応 Applicable for button sewing/bartacking 钉扣机/套结机也能对应

※2 : TOUGH & DELICATEの略 Abbr. of TOUGH & DELICATE TOUGH & DELICATEの缩写

記号 SYSTEM 记号	他社記号 OTHER BRANDS SYSTEM 其他公司记号	先端 POINT 针头	針図 ILLUSTRATION 针图	用途・特徴 Application/Feature 用途・特征	番手 NEEDLE SIZE 针号
DP×17SF				A : 2.00 D : 39.00 N : 16.00	9 10 65 70
DP×17NS				A : 2.00 D : 39.00 N : 16.00	14 90
DP×17-SK				A : 2.00 D : 39.00 N : 16.00-13.50	14 16 18 19 20 21 22 23 24 90 100 110 120 125 130 140 160 180
DP×17RS				A : 2.00 D : 39.00 N : 16.00-13.00	18 19 20 21 22 23 24 110 120 125 130 140 160 180
DP×17HS				A : 2.00 D : 39.00 N : 16.00-13.00	11 18 20 21 22 23 24 25 75 110 125 130 140 160 180 200
DP-C80				A : 2.00 D : 39.00 N : 13.00	19 20 21 22 23 24 25 120 125 130 140 160 180 200
DP-C80-NY2				A : 2.00 D : 39.00 N : 16.00-13.00	18 19 21 22 23 110 120 130 140 160
DP-C119-NY2				A : 2.00 D : 39.00 N : 13.00	19 22 23 120 140 160
DP-N29				A : 2.00 D : 39.00 N : 10.00	11 14 16 18 75 90 100 110
DP-N45				A : 2.00 D : 39.00 N : 19.00	18 110
DP×35R	134-35 2134-35 SY7225			A : 2.00 D : 38.20 N : 16.00-13.50	8 9 10 11 12 13 14 16 18 19 20 21 60 65 70 75 80 85 90 100 110 120 125 130 22 22½ 23 23½ 24 25 140 150 160 170 180 200
NEW STANDARD DP×35R++	134-35 2134-35 SY7225			A : 2.00 D : 38.20 N : 16.00	9 10 11 12 13 14 16 18 19 20 21 22 65 70 75 80 85 90 100 110 120 125 130 140 22½ 23 23½ 24 150 160 170 180
DP×35R-SK				A : 2.00 D : 38.20 N : 13.50	14 16 18 19 20 21 22 23 90 100 110 120 125 130 140 160
DP-C126-NY2				A : 2.00 D : 38.20 N : 13.50	18 19 21 22 110 120 130 140

※1 : ボタン付け/門止めにも対応 Applicable for button sewing/bartacking 钉扣机/套结机也能对应

※2 : TOUGH & DELICATEの略 Abbr. of TOUGH & DELICATE TOUGH & DELICATEの缩写

記号 SYSTEM 记号	他社記号 OTHER BRANDS SYSTEM 其他公司记号	先端 POINT 针头	針図 ILLUSTRATION 针图	A D	用途・特徴 Application/Feature 用途・特征	番手 NEEDLE SIZE 针号
--------------------	---------------------------------------	-------------------	--------------------------	------	---------------------------------------	-------------------------

カッティングポイント
Cutting Point
剑尾针针尖

記号 Code 记号							
形状縫い目 Shape/Seam 形状・针脚							

カッティングポイント(M)
Small Cutting Point - (M)
小剑尾针 (M)

記号 Code 记号						
形状縫い目 Shape/Seam 形状・针脚						

VR	DIA左45°傾斜 DIA at 45 degrees to left DIA左45°傾斜	PCL	縦メス 短溝左ひねり Narrow wedge point with left-twist point groove 扁针头 针槽向左扭	PCR	縦メス 短溝右ひねり Narrow wedge point with right-twist point groove 扁针头 针槽向右扭	LLCR	45°ひねり 短溝右ひねり 45-degree twist with right-twist point groove 45°斜扁针头 针槽向右扭
----	--	-----	---	-----	--	------	--













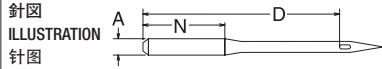

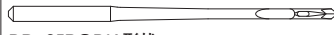





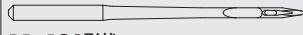



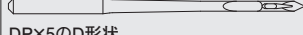

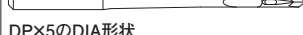

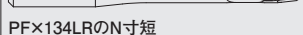

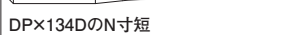

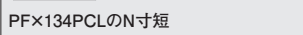

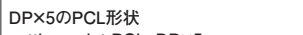

製品名称+S→カッティングポイント
Product name+S→Cutting point
产品名称+S→剑尾针针尖







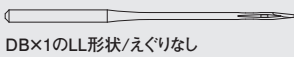

例) DP×17S 14
ex) DP×17S 14
例子) DP×17S 14

番手+S→ボールポイント
Needle size+S→Ball point
针号+S→圆头

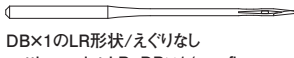
例) DP×17 14S
ex) DP×17 14S
例子) DP×17 14S

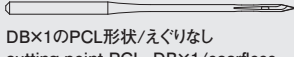

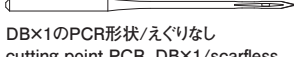

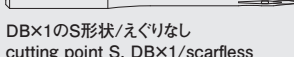











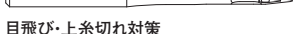

DP×17LL	135X16TW 135X16NTW SY3370		 DP×17のLL形状 cutting point LL, DP×17 DP×17的LL形状	A : 2.00 D : 39.00 N : 13.50-13.00	20 21 22 23 24 125 130 140 160 180
DP×17LR.	135X16RTW		 DP×17のLR形状 cutting point LR, DP×17 DP×17的LR形状	A : 2.00 D : 39.00 N : 16.00-13.00	14 16 18 19 20 21 22 23 24 90 100 110 120 125 130 140 160 180
DP×17S.	135X17S		 DP×17のS形状 cutting point S, DP×17 DP×17的S形状	A : 2.00 D : 39.00 N : 16.00-13.00	14 16 18 19 20 21 22 23 24 25 90 100 110 120 125 130 140 160 180 200
DP×17P	135X16NW 135X16W SY3371 SY3381		 DP×17のP形状 cutting point P, DP×17 DP×17的P形状	A : 2.00 D : 39.00 N : 16.00-13.00	12 14 16 18 19 20 21 22 23 24 25 80 90 100 110 120 125 130 140 160 180 200
DP×17D			 DP×17のD形状 cutting point D, DP×17 DP×17的D形状	A : 2.00 D : 39.00 N : 16.00-13.00	14 16 18 19 20 21 22 23 24 90 100 110 120 125 130 140 160 180
DP×17DIA	135X16DIA		 DP×17のDIA形状 cutting point DIA, DP×17 DP×17的DIA形状	A : 2.00 D : 39.00 N : 16.00-13.00	16 18 19 20 21 22 23 24 25 100 110 120 125 130 140 160 180 200
DP×17TQ.			 DP×17のTQ形状 cutting point TQ, DP×17 DP×17的TQ形状	A : 2.00 D : 39.00 N : 16.00-13.50	14 16 18 19 21 22 23 90 100 110 120 130 140 160
DP×35LL.	134-35LL 2134-35LL SY7237		 DP×35RのLL形状 cutting point LL, DP×35R DP×35R的LL形状	A : 2.00 D : 38.20 N : 13.50	12 14 16 18 19 21 22 23 24 25 80 90 100 110 120 130 140 160 180 200
DP×35LR.	134-35LR 2134-35LR SY7227		 DP×35RのLR形状 cutting point LR, DP×35R DP×35R的LR形状	A : 2.00 D : 38.20 N : 13.50	10 12 13 14 16 18 19 20 21 22 22½ 70 80 85 90 100 110 120 125 130 140 150 23 24 25 160 180 200
DP×35S.	134-35S 2134-35S SY7228		 DP×35RのS形状 cutting point S, DP×35R DP×35R的S形状	A : 2.00 D : 38.20 N : 13.50	14 16 18 19 21 22 23 90 100 110 120 130 140 160
DP×35P.	134-35P 2134-35P SY7234		 DP×35RのP形状 cutting point P, DP×35R DP×35R的P形状	A : 2.00 D : 38.20 N : 13.50	10 12 14 16 19 21 22 70 80 90 100 120 130 140

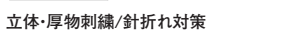
記号 SYSTEM 记号	他社記号 OTHER BRANDS SYSTEM 其他公司记号	先端 POINT 针头	針図 ILLUSTRATION 针图	用途・特徴 Application/Feature 用途・特征	番手 NEEDLE SIZE 针号
DP×35D.	134-35D		 DP×35RのD形状 cutting point D, DP×35R DP×35R的D形状	A : 2.00 D : 38.20 N : 13.50	14 16 18 19 20 21 22 22½ 23 24 90 100 110 120 125 130 140 150 160 180
DP×35DIA			 DP×35RのDIA形状 cutting point DIA, DP×35R DP×35R的DIA形状	A : 2.00 D : 38.20 N : 13.50	14 16 18 19 20 21 22 23 24 25 90 100 110 120 125 130 140 160 180 200
DP×134LL	134LL 135X8NTW 797LL SY1991 SY6805		 DP×5のLL形状 cutting point LL, DP×5 DP×5的LL形状	A : 2.00 D : 33.90 N : 13.50-11.50	10 11 12 13 14 16 18 19 21 22 23 24 70 75 80 85 90 100 110 120 130 140 160 180
DP×134LR	134LR 135X8 797LR SY1984 SY6806		 DP×5のLR形状 cutting point LR, DP×5 DP×5的LR形状	A : 2.00 D : 33.90 N : 13.50-11.50	9 10 11 12 13 14 16 18 19 20 21 22 65 70 75 80 85 90 100 110 120 125 130 140 22½ 23 24 25 150 160 180 200
DP×134S	134S 135X8NCR 797S SY1992 SY6802		 DP×5のS形状 cutting point S, DP×5 DP×5的S形状	A : 2.00 D : 33.90 N : 13.50-11.50	9 10 11 12 13 14 16 18 19 20 21 22 65 70 75 80 85 90 100 110 120 125 130 140 22½ 23 25 150 160 200
DP×134P	134P 135X6NW 797P SY1988 SY6801		 DP×5のP形状 cutting point P, DP×5 DP×5的P形状	A : 2.00 D : 33.90 N : 13.50-11.50	10 11 12 13 14 16 18 19 20 21 22 23 70 75 80 85 90 100 110 120 125 130 140 160
DP×134D	134D 135X8TRI 797D SY1981 SY6807		 DP×5のD形状 cutting point D, DP×5 DP×5的D形状	A : 2.00 D : 33.90 N : 13.50-11.50	10 11 12 13 14 16 18 19 20 21 22 70 75 80 85 90 100 110 120 125 130 140 22½ 23 24 25 150 160 180 200
DP×134DIA	134DI 135X8DIA 797DIA SY1987 SY1989		 DP×5のDIA形状 cutting point DIA, DP×5 DP×5的DIA形状	A : 2.00 D : 33.90 N : 13.50-11.50	10 12 14 16 18 19 20 21 22 23 24 70 80 90 100 110 120 125 130 140 160 180
PF×134KKLR	134KKLR 797KKLR SY6760		 PF×134LRのN寸短 short shank, PF×134LR PF×134LR的短柄针	A : 2.00 D : 33.90 N : 11.50	9 10 11 12 14 16 18 19 22 65 70 75 80 90 100 110 120 140
PF×134KKD	134KKD		 DP×134DのN寸短 short shank, DP×134D DP×134D的短柄针	A : 2.00 D : 33.90 N : 11.50	14 16 90 100
PF×134KKPCL	134KKPCL SY6761		 PF×134PCLのN寸短 short shank, PF×134PCL PF×134PCL的短柄针	A : 2.00 D : 33.90 N : 11.50	9 10 11 12 14 16 18 19 20 21 22 65 70 75 80 90 100 110 120 125 130 140
PF×134PCL	134PCL 797PCL 797PCLS SY6793 SY6799		 DP×5のPCL形状 cutting point PCL, DP×5 DP×5的PCL形状	A : 2.00 D : 33.90 N : 14.50-11.50	8 9 10 11 12 13 14 16 18 19 20 21 60 65 70 75 80 85 90 100 110 120 125 130 22 22½ 23 24 25 140 150 160 180 200
PF×134PCR	134PCR 134PCRS 797PCR SY6794		 DP×5のPCR形状 cutting point PCR, DP×5 DP×5的PCR形状	A : 2.00 D : 33.90 N : 14.50-11.50	10 11 12 13 14 16 18 19 21 22 70 75 80 85 90 100 110 120 130 140
PF×134VR	134VR SY6804		 DP×5のVR形状 cutting point VR, DP×5 DP×5的VR形状	A : 2.00 D : 33.90 N : 14.50-11.50	14 16 18 19 21 22 90 100 110 120 130 140
DP×F22	134KKS SY6758		 DP×134SのN寸短 short shank, DP×134S DP×134S的短柄针	A : 2.00 D : 33.90 N : 12.50-11.50	9 10 11 12 14 16 18 19 20 21 22 23 65 70 75 80 90 100 110 120 125 130 140 160
DB×F2	1738LR 16X230NRTW 16X230RTW		 DB×1のLR形状 cutting point LR, DB×1 DB×1的LR形状	A : 1.63 / 1.91 / 2.03 D : 33.80 N : 16.00-10.50	9 11 12 13 14 16 18 / 19 / 20 21 22 65 75 80 85 90 100 110 / 120 / 125 130 140 23 24 25 160 180 200
DB-F42			 DB×A20のLR形状 cutting point LR, DB×A20 DB×A20的LR形状	A : 1.63 D : 33.80 N : 12.50-11.50	19 20 21 22 120 125 130 140
DB×F17	1738S		 DB×1のS形状 cutting point S, DB×1 DB×1的S形状	A : 1.63 / 1.91 D : 33.80 N : 16.00-12.50	8 9 10 11 12 14 16 18 / 19 60 65 70 75 80 90 100 110 / 120

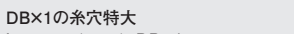
記号 SYSTEM 记号	他社記号 OTHER BRANDS SYSTEM 其他公司记号	先端 POINT 针头	針図 ILLUSTRATION 针图	用途・特徴 Application/Feature 用途・特征	番手 NEEDLE SIZE 针号
TF×2	34LL 16X2NTW 287LL 563LL SY2088		 DB×1のLL形状/えぐりなし cutting point LL, DB×1/scarfless DB×1的LL形状/无针冠	A : 1.63 / 1.91 / 2.03 D : 33.80 N : 13.50-10.50	7 8 9 10 11 12 13 14 16 18 / 19 / 20 55 60 65 70 75 80 85 90 100 110 / 120 / 125 21 22 23 24 25 130 140 160 180 200
TF×2LR	16X2NRTW 16X2RTW 34LR 563LR SY2087		 DB×1のLR形状/えぐりなし cutting point LR, DB×1/scarfless DB×1的LR形状/无针冠	A : 1.63 / 1.91 / 2.03 D : 33.80 N : 13.50-10.50	7 8 9 10 11 12 13 14 16 18 / 19 / 20 55 60 65 70 75 80 85 90 100 110 / 120 / 125 21 22 23 24 25 130 140 160 180 200
TF×4	34PCL 16X4 SY2174 SY2175		 DB×1のPCL形状/えぐりなし cutting point PCL, DB×1/scarfless DB×1的PCL形状/无针冠	A : 1.63 / 1.91 / 2.03 D : 33.80 N : 13.50-11.00	8 9 10 11 12 13 14 16 18 / 19 / 20 21 60 65 70 75 80 85 90 100 110 / 120 / 125 130
TF×6	16X6 34PCR SY2220		 DB×1のPCR形状/えぐりなし cutting point PCR, DB×1/scarfless DB×1的PCR形状/无针冠	A : 1.63 / 1.91 / 2.03 D : 33.85 N : 13.50-11.00	8 9 10 11 12 13 14 16 18 / 19 / 20 21 60 65 70 75 80 85 90 100 110 / 120 / 125 130 22 23 24 140 160 180
TF×F8	16X2NCR 34S SY2078		 DB×1のS形状/えぐりなし cutting point S, DB×1/scarfless DB×1的S形状/无针冠	A : 1.63 / 1.91 / 2.03 D : 33.80 N : 13.50-10.50	7 8 9 10 11 12 14 16 18 / 19 / 21 22 55 60 65 70 75 80 90 100 110 / 120 / 130 140

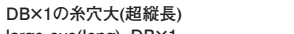
本縫い Lockstitch 平縫

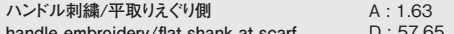
刺繍/ステッチ Embroidery/Top Stitch 刺繍/装饰缝

DB×K5			 DB×1の糸穴大 large eye, DB×1 DB×1的大眼针	A : 1.62 / 1.91 D : 33.80 N : 16.00-12.50	8 9 10 11 12 13 14 16 18 / 19 60 65 70 75 80 85 90 100 110 / 120
DB×K5KK			 DB×K5のN寸短 short shank, DB×K5 DB×K5的短柄针	A : 1.62 D : 33.80 N : 13.50	9 10 11 12 14 65 70 75 80 90
DB×K5-NY			 針折れ対策 for needle breakage 断针对策	A : 1.62 D : 33.80 N : 16.00	8 9 10 11 12 14 60 65 70 75 80 90
DB×K5Z1			 目飛び・上糸切れ対策 for skipped stitches, upper thread cut 跳线・断缝线对策	A : 1.62 D : 33.80 N : 16.00	8 9 10 11 12 14 16 18 60 65 70 75 80 90 100 110
DB×K5Z1-NY			 針折れ対策 for needle breakage 断针对策	A : 1.62 D : 33.80 N : 16.50	9 10 11 12 14 65 70 75 80 90
DB×K5Z2-NY			 立体・厚物刺繍/針折れ対策 3D, thick fabric/for needle breakage 立体・厚重面料刺繍/断针对策	A : 1.62 D : 33.80 N : 13.50	9 10 11 12 14 65 70 75 80 90
DB×7ST			 DB×1の糸穴特大 large eye(extra), DB×1 DB×1的特大眼针	A : 1.63 D : 33.00 N : 16.00-11.50	9 11 12 14 16 18 65 75 80 90 100 110
DB×9ST			 DB×1の糸穴大(超縦長) large eye(long), DB×1 DB×1的大眼针(超纵长)	A : 1.63 D : 33.80 N : 16.00	9 11 14 16 18 65 75 90 100 110
PH-C70	CEX3		 ハンドル刺繍/平取りえぐり側 handle embroidery/flat shank at scarf 毛巾绣/平面针冠侧	A : 1.63 D : 57.65 N : 26.00	11 14 16 18 19 21 75 90 100 110 120 130
PH×1	137X1 SY5901 253C		 人形植毛 doll hair planting 玩具植毛	A : 1.52 D : 57.50 N : 26.00-10.00	9 11 12 13 14 15 16 18 19 20 21 22 65 75 80 85 90 95 100 110 120 125 130 140 23 26 160 230

記号 SYSTEM 记号	他社記号 OTHER BRANDS SYSTEM 其他公司记号	先端 POINT 针头	針図 ILLUSTRATION 针图	用途・特徴 Application/Feature 用途・特征	番手 NEEDLE SIZE 针号
PH×1SM	137X1SM	HO		PH×1のフック浅 shallow hook, PH×1 PH×1浅钩	A : 1.46 D : 58.00 N : 26.00 14 16 18 19 90 100 110 120
CP×1	150 29-C-150 29-DEA SY1902 SY6960	R		ピンポイント刺繍 pinpoint embroidery 平绣	A : 2.02 D : 34.50 N : 18.00 12 14 16 18 19 21 22 80 90 100 110 120 130 140
CP×1J		R		CP×1の厚平取り溝側左/H寸長 thin flat shank at long groove-left, CP×1/long scarf CP×1の平面针厚针槽側左/H寸长	A : 2.02 D : 34.50 N : 18.00 14 16 18 19 21 22 90 100 110 120 130 140
CP×2		R		CP×1のN寸短 short shank, CP×1 CP×1の短柄针	A : 2.02 D : 34.50 N : 14.00 14 16 18 19 21 22 23 90 100 110 120 130 140 160
CP×12	151 151S 29-C-151 29-DHA	HO		ピンポイント刺繍 pinpoint embroidery 平绣	A : 2.02 D : 37.00 N : 18.00 11 12 14 16 18 19 20 21 22 23 75 80 90 100 110 120 125 130 140 160
CP×12J		HO		CP×12の厚平取り溝側 thin flat shank at long groove, CP×12 CP×12の平面针厚针槽側	A : 2.02 D : 37.00 N : 18.00 19 20 21 22 23 120 125 130 140 160
CP×17		HO		CP×12のN寸短 short shank, CP×12 CP×12の短柄针	A : 2.02 D : 39.30 N : 12.50 11 14 16 18 19 21 75 90 100 110 120 130
CP×170		HO		CP×17のフック・えぐり・E寸改造 hook/scarf/total length revised CP×17 CP×17针钩・针冠・E寸改造针	A : 2.02 D : 37.30 N : 12.50 14 16 18 19 21 90 100 110 120 130
CP×200		R		CP×2の平取りえぐり側 flat shank at scarf, CP×2 CP×2の平面针针冠側	A : 2.02 D : 34.50 N : 14.00 14 16 18 19 90 100 110 120

本縫い Lockstitch 平縫

千鳥縫い/穴かがり/冪止め Zigzag Stitch/Buttonholing/Bartacking 曲折縫/锁眼/套结

DP×5	134 135X11 135X5 135X65 797	R		千鳥縫い/穴かがり/冪止め*3 zigzag stitch/buttonholing/bartacking *3 曲折縫/锁眼/冪固縫*3	A : 2.00 D : 33.90 N : 12.50-11.50 7 8 9 10 11 12 13 14 16 18 19 20 55 60 65 70 75 80 85 90 100 110 120 125 21 22 22½ 23 23½ 24 25 130 140 150 160 170 180 200
NEW STANDARD DP×5++	134 135X11 135X5 135X65 797	R		TD*2ブレード/TDスカート/糸穴大 TD*2 blade/TD scarf/large eye TD*2针杆/TD针冠/大针眼	A : 2.00 D : 33.90 N : 13.50-11.50 7 8 9 10 11 12 13 14 16 18 19 20 55 60 65 70 75 80 85 90 100 110 120 125 21 22 22½ 23 23½ 24 25 130 140 150 160 170 180 200
DP×5KN		S		地糸切れ対策 for fabric yarn breakage 面料断线対策	A : 2.00 D : 33.90 N : 12.50 8 9 10 11 12 60 65 70 75 80
DP×5SF		S		地糸切れ対策 for fabric yarn breakage 面料断线対策	A : 2.00 D : 33.90 N : 12.50 9 10 11 65 70 75
DP×5NS		SPI		ダウン吹き出し・パッカリング対策 for down migration, puckering 羽绒面料跑绒・缝迹收缩对策	A : 2.00 D : 33.90 N : 12.50 8 9 10 11 12 14 60 65 70 75 80 90

*2 : TOUGH & DELICATEの略 Abbr. of TOUGH & DELICATE TOUGH & DELICATEの缩写

*3 : 2本針本縫いにも対応 Applicable for 2-needle lockstitch 双针平缝机也能对应

記号 SYSTEM 记号	他社記号 OTHER BRANDS SYSTEM 其他公司记号	先端 POINT 针头	針図 ILLUSTRATION 针图	用途・特徴 Application/Feature 用途・特征	番手 NEEDLE SIZE 针号
DP×134-SK				A : 2.00 D : 33.90 N : 13.50-11.50 目飛び対策 for skipped stitches 跳线对策	14 16 18 19 20 21 22 23 90 100 110 120 125 130 140 160
PF×134KK	134KK 797KK B-134 SY6759			A : 2.00 D : 33.90 N : 11.50 DP×5のN寸短 short shank, DP×5 DP×5的短柄针	8 10 11 12 13 14 16 18 19 21 22 60 70 75 80 85 90 100 110 120 130 140
DP×1	135X1 354 61B SY1451			A : 2.00 D : 31.90 N : 12.50-11.50 千鳥縫い/穴かがり/門止め zigzag stitch/buttonholing/bartacking 曲折缝/锁扣眼/加固缝	8 9 10 11 12 13 14 16 18 19 20 21 60 65 70 75 80 85 90 100 110 120 125 130 22 22½ 23 24 25 140 150 160 180 200
DP×58				A : 2.00 D : 33.90 N : 12.50-11.50 千鳥縫い zigzag stitch 曲折缝	9 10 11 12 14 16 18 19 65 70 75 80 90 100 110 120
DP×438	438 265 SY8122			A : 2.00 D : 33.90 N : 13.50 千鳥縫い zigzag stitch 曲折缝	8 9 10 11 12 14 16 18 19 60 65 70 75 80 90 100 110 120
DP×438KK	438KK 265KK SY8763			A : 2.00 D : 33.90 N : 11.50 DP×438のN寸短 short shank, DP×438 DP×438的短柄针	10 12 14 16 18 19 70 80 90 100 110 120
SG×1906	1906 135X53 SY1906			A : 2.00 D : 33.90 N : 13.50-11.50 千鳥縫い/ファンデーション zigzag stitch/foundation 曲折缝/内衣	8 9 10 11 12 13 14 16 18 19 20 21 60 65 70 75 80 85 90 100 110 120 125 130
SG×1963	135X35LBALL SY1963			A : 2.00 D : 33.90 N : 13.50 SG×1906全番手ボールサイズ同一 same ball for all needle sizes, SG×1960 SG×1906所有针号圆头大小相同	8 9 10 11 12 60 65 70 75 80
SG×1965	135X53MBALL SY1965			A : 2.00 D : 33.90 N : 13.50-12.50 SG×1906全番手ボールサイズ同一 same ball for all needle sizes, SG×1960 SG×1906所有针号圆头大小相同	9 10 11 12 14 65 70 75 80 90
EB×750	750 750SC SY6482			A : 1.63 D : 33.20 N : 12.50 フラット加工 flat shank at scarf 平面加工	9 11 12 14 16 65 75 80 90 100
EB×755	501SC 501 1807 755H SY6480			A : 1.63 D : 33.00 N : 12.00 鳩目穴かがり eyelet buttonholing 圆头锁眼机	8 9 10 11 12 14 16 18 19 20 21 23 60 65 70 75 80 90 100 110 120 125 130 160
EB×755NS				A : 1.63 D : 33.00 N : 12.00 パッカリング対策 for puckering 缝迹收缩对策	11 12 14 75 80 90

本縫い Lockstitch 平縫

ボタン付け Button Sewing 釦扣

DP×17KK				A : 2.00 D : 39.00 N : 11.50 DP×17のN寸短 short shank, DP×17 DP×17的短柄针	11 14 16 18 75 90 100 110
DP×17KK2				A : 2.00 D : 39.00 N : 13.00 DP×17のN寸短 short shank, DP×17 DP×17的短柄针	11 75

記号 SYSTEM 记号	他社記号 OTHER BRANDS SYSTEM 其他公司记号	先端 POINT 针头	針図 ILLUSTRATION 针图	用途・特徴 Application/Feature 用途・特征	番手 NEEDLE SIZE 针号
--------------------	---------------------------------------	-------------------	--------------------------	---------------------------------------	-------------------------

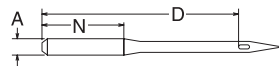

本縫い Lockstitch 平縫

玉縁縫い Welting 袋口縫

MT×190			パッドとじ pad sewing 滾边	A : 2.00 D : 44.50 N : 13.50	9 10 11 12 14 16 18 19 20 21 22 65 70 75 80 90 100 110 120 125 130 140 22½ 23 23½ 24 25 150 160 170 180 200
MT×190NS			バックリング対策 for puckering 縫迹收缩对策	A : 2.00 D : 44.50 N : 13.50	11 14 75 90

本縫い Lockstitch 平縫













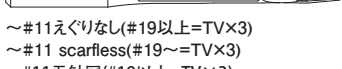

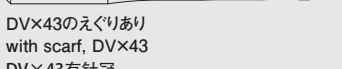

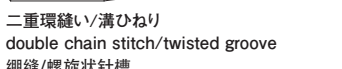

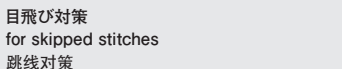



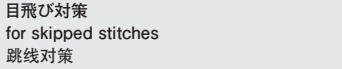

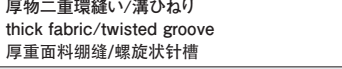

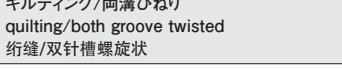

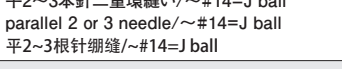

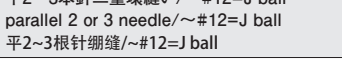

まつり/すくい縫い Blind Stitch 縷縫

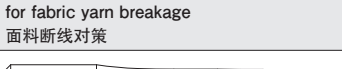
LW×1T	29BD 1717TP 29-12 SY7032		伏せ縫い/まつり縫い/平取り溝側左 hemming/blind stitch/ flat shank at long groove-left 折縫/縷縫/平面针槽側左	A : 2.03 D : 36.20 N : 10.00	8 9 10 11 12 14 16 18 19 21 60 65 70 75 80 90 100 110 120 130
LW×2T	29BL 2140BE 29-34 3140TP SY7395		伏せ縫い/まつり縫い/平取り溝側左 hemming/blind stitch/ flat shank at long groove-left 折縫/縷縫/平面针槽側左	A : 2.03 D : 39.90 N : 15.00	8 9 10 11 12 13 14 16 18 19 21 60 65 70 75 80 85 90 100 110 120 130
LW×3T	251 1715F 29-C-300 29CA SY3690		盲縫い/まつり縫い/平取り溝側右 blind stitch/flat shank at long groove-right 暗縫/縷縫/平面针槽側右	A : 2.03 D : 38.70 N : 15.50	8 9 10 11 12 13 14 15 16 17 18 19 60 65 70 75 80 85 90 95 100 105 110 120 20 21 22 125 130 140
LW×4T	251 1715F 29-C-300 29CA SY3690		盲縫い/まつり縫い/平取り溝側右 blind stitch/flat shank at long groove-right 暗縫/縷縫/平面针槽側右	A : 2.03 D : 38.70 N : 15.50	8 9 11 12 14 16 60 65 75 80 90 100
LW×5T			奥まつり縫い/平取り溝側右 blind felling/flat shank at long groove-right 盲縷縫/平面针槽側右	A : 2.03 D : 40.70 N : 15.50	9 10 11 12 13 14 15 16 17 19 0 5 10 15 20 25 30 35 40 50 65 70 75 80 85 90 95 100 105 120
LW×6T	29BL 2140BE 29-34 3140TP SY7395		伏せ縫い/まつり縫い/平取り溝側左 hemming/blind stitch/ flat shank at long groove-left 折縫/縷縫/平面针槽側左	A : 2.03 D : 40.00 N : 15.00	7 8 9 10 11 12 13 14 16 18 19 1½ 2 2½ 3 3½ 4 4½ 5 55 60 65 70 75 80 85 90 100 110 120
LW×251EU	251EU 1669 1715 SY7253		盲縫い/まつり縫い/平取り溝側右 blind stitch/flat shank at long groove-right 暗縫/縷縫/平面针槽側右	A : 2.03 D : 38.90 N : 14.50	8 9 10 11 12 14 16 18 60 65 70 75 80 90 100 110
LW-C5	29BK 2186TP 29-39 SY7033		伏せ縫い/まつり縫い/平取り溝側右 hemming/blind stitch/flat shank at long groove-right 折縫/縷縫/平面针槽側右	A : 2.03 D : 36.20 N : 10.00	8 9 10 11 12 14 16 18 19 21 60 65 70 75 80 90 100 110 120 130

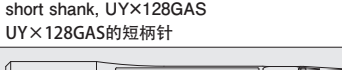
記号 SYSTEM 记号	他社記号 OTHER BRANDS SYSTEM 其他公司记号	先端 POINT 针头	針図 ILLUSTRATION 针图	用途・特徴 Application/Feature 用途・特征	番手 NEEDLE SIZE 针号
--------------------	---------------------------------------	-------------------	--------------------------	---------------------------------------	-------------------------

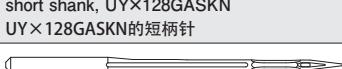
環縫い Chain Stitch 环缝

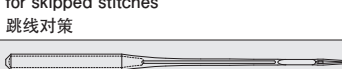
二重環縫い/扁平縫い Double Chain Stitch/Covering Chain Stitch 双重链式缝/绷缝

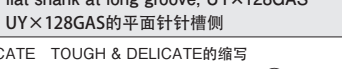
DV×1	UY121GHS UY121GS 1628 62X21 759		 平2~3本針二重環縫い parallel 2 or 3 needle 平2~3根针绷缝	A : 2.00 D : 39.00 N : 13.50 E : 43.70-46.00	7 8 9 10 11 12 13 14 16 18 19 20 55 60 65 70 75 80 85 90 100 110 120 125 21 22 23 24 25 130 140 160 180 200
DV×43	62X43 SY3516		 ~#11えぐりなし(#19以上=TV×3) ~#11 scarfless(#19~=TV×3) ~#11无针冠(#19以上=TV×3)	A : 2.00 D : 39.00 N : 13.50 E : 44.70-44.90	9 10 11 12 13 14 16 18 65 70 75 80 85 90 100 110
DV×G9			 DV×43のえぐりあり with scarf, DV×43 DV×43有针冠	A : 2.00 D : 39.00 N : 13.50 E : 44.50-44.80	8 9 11 12 13 14 60 65 75 80 85 90
DV×57	62X57 5640 SY3260 SY3260-07		 二重環縫い/溝ひねり double chain stitch/twisted groove 绷缝/螺旋状针槽	A : 2.00 D : 38.60 N : 13.00 E : 44.20	9 10 11 12 13 14 16 18 19 20 21 22 65 70 75 80 85 90 100 110 120 125 130 140 22½ 23 24 150 160 180
DV×57-NY2			 目飛び対策 for skipped stitches 跳线对策	A : 2.00 D : 38.60 N : 13.00 E : 44.20	18 19 20 21 22 110 120 125 130 140
DV×57LE			 DV×57の糸穴大 large eye, DV×57 DV×57の大眼針	A : 2.00 D : 38.70 N : 13.00 E : 44.70	16 18 19 20 21 22 24 100 110 120 125 130 140 180
DV×57LE-NY2			 目飛び対策 for skipped stitches 跳线对策	A : 2.00 D : 38.60 N : 13.00 E : 44.20	11 12 14 16 18 19 75 80 90 100 110 120
DV×59	62X59 SY4112		 厚物二重環縫い/溝ひねり thick fabric/twisted groove 厚重面料绷缝/螺旋状针槽	A : 2.00 D : 41.50 N : 13.00 E : 48.50	14 16 18 19 20 21 22 23 24 90 100 110 120 125 130 140 160 180
DV×600			 キルティング/両溝ひねり quilting/both groove twisted 绉缝/双针槽螺旋状	A : 2.00 D : 54.00 N : 20.00-17.00 E : 63.00	18 21 110 130
DV×63	B63 B-63 SY7380		 平2~3本針二重環縫い/~#14=J ball parallel 2 or 3 needle/~#14=J ball 平2~3根针绷缝/~#14=J ball	A : 2.00 D : 39.00 N : 14.50-13.50 E : 43.70	7 8 9 10 11 12 13 14 16 18 19 20 55 60 65 70 75 80 85 90 100 110 120 125 21 22 23 130 140 160
UY×128GAS	1280 MY1040 MY1044 SY7292 UY128GAS		 平2~3本針二重環縫い/~#12=J ball parallel 2 or 3 needle/~#12=J ball 平2~3根针绷缝/~#12=J ball	A : 2.00 D : 39.00 N : 14.50-13.50 E : 44.70-44.60	7 8 9 10 11 12 13 14 16 18 19 20 55 60 65 70 75 80 85 90 100 110 120 125 21 22 22½ 23 23½ 25 130 140 150 160 170 200
NEW STANDARD UY×128GAS++	1280 MY1040 MY1044 SY7292 UY128GAS		 TD*2ブレード/TDスカーフ/糸穴大 TD*2 blade/TD scarf/large eye TD*2针杆/TD针冠/大针眼	A : 2.00 D : 39.00 N : 14.50 E : 44.70-44.60	7 8 9 10 11 12 13 14 16 18 19 20 55 60 65 70 75 80 85 90 100 110 120 125 21 22 22½ 23 23½ 25 130 140 150 160 170 200
UY×128GASKN			 地糸切れ対策 for fabric yarn breakage 面料断线对策	A : 2.00 D : 39.00 N : 14.50 E : 44.80-44.60	7 8 9 10 11 12 55 60 65 70 75 80
UY×128KK			 UY×128GASのN寸短 short shank, UY×128GAS UY×128GAS的短柄针	A : 2.00 D : 39.00 N : 12.00 E : 44.70	7 8 9 10 11 55 60 65 70 75
UY×128KK-KN			 UY×128GASKNのN寸短 short shank, UY×128GASKN UY×128GASKN的短柄针	A : 2.00 D : 39.00 N : 12.00 E : 44.80-44.60	7 8 9 10 11 55 60 65 70 75
UY×128GAS-SK			 目飛び対策 for skipped stitches 跳线对策	A : 2.00 D : 39.00 N : 14.50-13.50 E : 44.70	14 16 18 19 20 21 90 100 110 120 125 130
UY×128FL			 UY×128GASの平取り溝側 flat shank at long groove, UY×128GAS UY×128GASの平面针槽側	A : 2.00 D : 39.00 N : 14.50 E : 44.70	8 9 10 60 65 70

※2 : TOUGH & DELICATEの略 Abbr. of TOUGH & DELICATE TOUGH & DELICATE的缩写

記号 SYSTEM 记号	他社記号 OTHER BRANDS SYSTEM 其他公司记号	先端 POINT 针头	針図 ILLUSTRATION 针图	用途・特徴 Application/Feature 用途・特征	番手 NEEDLE SIZE 针号
DV-C65				A : 2.00 D : 39.00 N : 14.50 E : 44.70 UY×128GASの平取り溝側 flat shank at long groove. UY×128GAS UY×128GAS的平面针针槽側	8 9 10 11 60 65 70 75
TV×1	149X1 SY2774			A : 2.00 D : 37.00 N : 13.50 E : 41.60-43.20 へム縫い/伏せ縫い/えぐりなし hemming/scarfless 包边/折缝/无针冠	7 8 9 10 11 12 13 14 16 18 19 20 55 60 65 70 75 80 85 90 100 110 120 125 21 22 23 130 140 160
TV×3	UY128GAS 149X3 SY3650 SY3651 UY124GS			A : 2.00 D : 39.00 N : 13.50 E : 45.00 脇縫い/＃18以下=DV×43 side sewing/＃18=DV×43 身縫縫和/＃18以下=DV×43	19 20 21 22 23 24 120 125 130 140 160 180
TV×5	149X5 62X45 62X53 SY4110 SY4151			A : 2.00 D : 41.40 N : 13.50 E : 46.50-47.50 伏せ縫い hemming 折缝	8 9 10 11 12 13 14 16 18 19 20 21 60 65 70 75 80 85 90 100 110 120 125 130 22 23 24 25 140 160 180 200
TV×5-SK				A : 2.00 D : 41.40 N : 13.50 E : 46.70 目飛び対策 for skipped stitches 跳线対策	12 80
TV×5HS				A : 2.00 D : 41.40 N : 13.50 E : 47.00-47.20 熱対策/LPコーティング heat resistance/LP coating 针热対策/LP涂层	18 19 21 110 120 130
TV×7	149X7 MY1002A SY2776			A : 2.00 D : 37.00 N : 13.50 E : 42.50-42.80 へム縫い/伏せ縫い hemming 包边/折缝	8 9 10 11 12 13 14 16 17 18 19 20 60 65 70 75 80 85 90 100 105 110 120 125 21 22 23 24 25 130 140 160 180 200
TV×7HS				A : 2.00 D : 37.00 N : 13.50 E : 42.30-42.80 熱対策/LPコーティング heat resistance/LP coating 针热対策/LP涂层	14 16 18 90 100 110
TV×64	B64 B-64 SY7045			A : 2.00 D : 36.60 N : 13.50 E : 41.10 伏せ縫い hemming 折缝	8 9 10 11 12 13 14 16 18 19 20 21 60 65 70 75 80 85 90 100 110 120 125 130 22 23 25 140 160 200
UO×113GS	UY113GS SY7090 UY113GHS			A : 2.00 D : 36.60 N : 14.50-13.50 E : 41.50 溝ひねり twisted groove 螺旋状针槽	8 9 10 11 12 13 14 16 18 19 20 21 60 65 70 75 80 85 90 100 110 120 125 130 22 140
UO×113GS-NY2				A : 2.00 D : 36.60 N : 13.50 E : 41.50 ～＃12=J ball/目飛び対策 ～＃12=J ball/for skipped stitches ～＃12=J ball/跳线対策	11 12 14 16 18 75 80 90 100 110
UY×121GBS	UY121GBS SY7284			A : 2.00 D : 39.00 N : 14.50-13.50 E : 43.70 平2～3本針二重環縫い parallel 2 or 3 needle 平2～3根针绷缝	9 10 11 12 14 16 18 19 21 65 70 75 80 90 100 110 120 130
SM×1014A	MY1014 MY1014A SY7255 UY8023GS			A : 1.48 D : 39.00 N : 15.50 E : 44.20 4本針偏平縫い/両溝/えぐりなし 4-needle interlock/double groove/scarfless 4针绷缝/双针槽/无针冠	8 9 10 11 12 14 60 65 70 75 80 90
SM×1014B	MY1014B SY7256			A : 1.48 D : 39.00 N : 15.50 E : 44.20 4本針偏平縫い/両溝/えぐりあり 4-needle interlock/double groove/with scarf 4针绷缝/双针槽/有针冠	8 9 10 11 12 14 16 18 60 65 70 75 80 90 100 110
SM×1014H	MY1014H			A : 1.48 D : 39.00 N : 15.50 E : 43.80 5本針偏平縫い/両溝/えぐりあり 5-needle interlock/double groove/with scarf 5针绷缝/双针槽/有针冠	9 10 11 12 65 70 75 80
FL×118A	SY7060 UY118GAS			A : 1.51 D : 36.60 N : 16.50 両溝/えぐりなし double groove/scarfless 双槽/无针冠	8 9 10 11 12 14 16 18 60 65 70 75 80 90 100 110
FL×118GBS	UY118GBS SY7061			A : 1.51 D : 36.60 N : 16.50 片溝/えぐりあり single groove/with scarf 单槽/有针冠	8 9 10 11 12 14 16 60 65 70 75 80 90 100
FL×118GCS	UY118GKS			A : 1.51 D : 36.60 N : 16.50 両溝/えぐりあり double groove/with scarf 双槽/有针冠	8 9 10 11 12 60 65 70 75 80

記号 SYSTEM 记号	他社記号 OTHER BRANDS SYSTEM 其他公司记号	先端 POINT 针头	針図 ILLUSTRATION 针图	用途・特徴 Application/Feature 用途・特征	番手 NEEDLE SIZE 针号
FL×118GCS-NY2				A : 1.51 D : 36.60 N : 16.50	9 10 11 65 70 75
FL×118GCSSF				A : 1.51 D : 36.60 N : 16.50	9 10 11 65 70 75
FL×118KK				A : 1.51 D : 36.60 N : 15.50	9 10 11 65 70 75
FL×118-SK				A : 1.51 D : 36.60 N : 16.50	8 9 10 11 60 65 70 75
FLG-1	36211			A : 1.51 N : 15.00 E : 41.20	7 8 9 10 11 12 55 60 65 70 75 80
FLG-8				A : 1.51 N : 15.00 E : 41.20	8 60

環縫い Chain Stitch 环缝

オーバーロック/インターロック Overlock/Safety Stitch 包缝

DC×1	81X1 621 MY1023 SY1225			A : 2.02 D : 28.60 N : 10.00	6 7 8 9 10 11 12 13 14 16 18 19 50 55 60 65 70 75 80 85 90 100 110 120 20 21 22 23 24 25 125 130 140 160 180 200
DC×1KN				A : 2.02 D : 28.60 N : 10.00	8 9 10 11 12 14 60 65 70 75 80 90
DC×1SF				A : 2.02 D : 28.60 N : 10.00	8 9 10 11 60 65 70 75
DC×1NS				A : 2.02 D : 28.60 N : 10.00	8 9 10 11 12 60 65 70 75 80
DC×27	B27 1886 MY1023 SY6120			A : 2.02 D : 28.60 N : 10.00	6 7 8 9 10 11 12 13 14 16 18 19 50 55 60 65 70 75 80 85 90 100 110 120 20 21 22 23 24 125 130 140 160 180
DC×27LE				A : 2.02 D : 28.60 N : 10.00	11 12 14 16 75 80 90 100
DC-N17				A : 2.02 D : 28.60 N : 13.00	6 7 8 9 10 11 12 13 14 16 18 19 50 55 60 65 70 75 80 85 90 100 110 120 20 21 22 125 130 140
DC-N25				A : 2.02 D : 28.60 N : 11.50	7 8 9 10 11 55 60 65 70 75

記号 SYSTEM 记号	他社記号 OTHER BRANDS SYSTEM 其他公司记号	先端 POINT 针头	針図 ILLUSTRATION 针图	用途・特徴 Application/Feature 用途・特征	番手 NEEDLE SIZE 针号
DC-N25SF				A : 2.02 D : 28.60 N : 11.50	9 65
DM×13	1886KK 82X13			A : 2.02 D : 28.60 N : 8.00	7 8 9 10 11 12 13 14 16 18 19 20 55 60 65 70 75 80 85 90 100 110 120 125 21 22 23 24 130 140 160 180
DM×13KN				A : 2.02 D : 28.60 N : 8.00	9 10 11 65 70 75
UN×154	UY8454GAS UY8545GHS UY8454GS			A : 2.02 D : 31.40 N : 14.50	7 8 9 10 11 12 13 14 16 18 21 55 60 65 70 75 80 85 90 100 110 130
UN-R7				A : 2.02 D : 31.40 N : 14.50	9 11 14 65 75 90
UN-R12				A : 2.02 D : 31.40 N : 14.50	9 11 14 65 75 90
UO×154				A : 2.02 D : 31.40 N : 14.50	6 7 8 9 10 11 12 13 14 16 18 19 50 55 60 65 70 75 80 85 90 100 110 120 20 22 125 140
UY×154GAS	UY154GAS 151X21 SY1431			A : 2.02 D : 31.60 N : 14.50	6 7 8 9 10 11 12 14 16 18 19 20 50 55 60 65 70 75 80 90 100 110 120 125 21 22 130 140
UY×154GCS	UY154GFS UY154GCS SY6431			A : 2.02 D : 31.60 N : 14.50	9 10 11 12 14 16 65 70 75 80 90 100
MR-R9	151X7 1435 1875 60M SY6200			A : 2.03 D : 29.20 N : 15.00	8 9 10 11 12 13 14 16 18 19 21 22½ 60 65 70 75 80 85 90 100 110 120 130 150

記号 SYSTEM 记号	他社記号 OTHER BRANDS SYSTEM 其他公司记号	先端 POINT 针头	針図 ILLUSTRATION 针图	用途・特徴 Application/Feature 用途・特征	番手 NEEDLE SIZE 针号
--------------------	---------------------------------------	-------------------	--------------------------	---------------------------------------	-------------------------

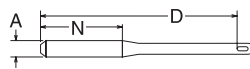

環縫い Chain Stitch 环缝

千鳥縫い/穴かがり/門止め Zigzag Stitch/Buttonholing/Bartacking 曲折缝/锁眼/套结

DO×5	142X5 SY1413		 鳩目穴かがり eyelet buttonholing 圆头锁眼机	A : 2.03 D : 31.30 N : 10.00	11 12 14 16 17 18 19 20 21 22 75 80 90 100 105 110 120 125 130 140
DO×5-NY			 針折れ対策 for needle breakage 断针对策	A : 2.03 D : 31.30 N : 10.00	16 18 19 100 110 120
DO×558	558		 鳩目穴かがり eyelet buttonholing 圆头锁眼机	A : 2.00 D : 33.90 N : 11.00	10 11 12 14 16 18 19 21 70 75 80 90 100 110 120 130
DO×558-NY2			 目飛び対策 for skipped stitches 跳线对策	A : 2.00 D : 33.90 N : 11.00	12 14 16 18 19 80 90 100 110 120

環縫い Chain Stitch 环缝

ボタン付け Button Sewing 钉扣

TQ×1	1661 1985 175X1 29S SY2851		 単環ボタン付け single thread chain stitch button sewing 单线钉扣	A : 1.75 D : 37.20 N : 11.50	9 10 11 12 13 14 16 18 19 20 21 22 65 70 75 80 85 90 100 110 120 125 130 140
TQ×3	1661LG 2018 175X3 SY4051 SY8727		 TQ×1のE寸長 long total length, TQ×1 TQ×1的长针	A : 1.75 D : 41.50 N : 11.50	11 12 14 16 18 19 20 21 22 75 80 90 100 110 120 125 130 140
TQ×7	2091 175X7 29L SY4531 SY8728		 TQ×3のE寸長/TQ×9のN寸長 long total length, TQ×3/long shank, TQ×9 TQ×3的长针/TQ×9的长柄针	A : 1.75 D : 47.00 N : 17.50	9 10 11 12 13 14 16 18 19 20 21 22 65 70 75 80 85 90 100 110 120 125 130 140 23 160
TQ×7KK			 TQ×7のN寸短 short shank, TQ×7 TQ×7的短柄针	A : 1.75 D : 47.00 N : 11.50	10 12 14 16 18 19 20 21 22 70 80 90 100 110 120 125 130 140
TQ×9	29LSS 1661ELG 175X9 1987 SY4538		 ボタン付け button sewing 钉扣	A : 1.75 D : 47.00 N : 14.00-10.00	9 10 11 12 14 16 18 19 20 21 22 65 70 75 80 90 100 110 120 125 130 140
SM×332LG	332LGHKSP		 根巻きボタン付け button neck wrapping 绕根钉扣	A : 1.98 D : 48.50 N : 18.00	11 12 14 16 18 19 21 22 23 75 80 90 100 110 120 130 140 160
SM×332EXTLG	332EXT.LG		 根巻きボタン付け button neck wrapping 绕根钉扣	A : 1.98 D : 54.50 N : 18.00	9 10 11 12 14 16 18 65 70 75 80 90 100 110
SM×332EXTLG-NY			 針振れ対策 for needle vibration 针晃对策	A : 1.98 D : 54.50 N : 18.00	11 12 14 16 18 75 80 90 100 110
SM×332SUPLG			 シャンクボタン付け shank button sewing 钉有脚纽扣	A : 1.98 D : 59.50 N : 18.00	12 14 16 80 90 100

記号 SYSTEM 记号	他社記号 OTHER BRANDS SYSTEM 其他公司记号	先端 POINT 针头	針図 ILLUSTRATION 针图	用途・特徴 Application/Feature 用途・特征	番手 NEEDLE SIZE 针号
--------------------	---------------------------------------	-------------------	--------------------------	---------------------------------------	-------------------------

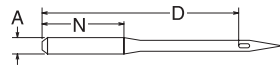

家庭用/職業用 Home-use/Professional 家庭用/职业用

HA×1	15×1 130/705H		 家庭用ミシン home-use sewing machine 家庭用缝纫机	A : 2.02 D : 33.80 N : 11.70	7 8 9 10 11 12 13 14 16 18 19 20 55 60 65 70 75 80 85 90 100 110 120 125 21 22 23 130 140 160
HA×1DE			 デニム denim 牛仔面料	A : 2.02 D : 33.80 N : 11.70	14 16 18 90 100 110
HA×1GT			 ジョーゼット georgette 乔其纱	A : 2.02 D : 33.80 N : 11.70	7 55
HA×1LL	15×2NTW 130LL 130/705HLL		 皮革 leather 皮革	A : 2.02 D : 33.80 N : 11.70	11 12 14 16 21 75 80 90 100 130
HA×1SP			 ニット/小型ロックミシン knit/overlock 针织面料/小型包缝机	A : 2.02 D : 33.80 N : 11.70	9 10 11 12 14 65 70 75 80 90
HA×1QU			 キルト quilting 绗缝	A : 2.02 D : 33.80 N : 11.70	11 12 14 75 80 90
HA×1EB			 刺繍 embroidery 刺绣	A : 2.02 D : 33.90 N : 11.70	11 14 75 90
HA×1BR			 クロムメッキ chrome plating 镀铬	A : 2.02 D : 33.80 N : 12.50-11.70	9 11 14 16 65 75 90 100
HA×130EBBR			 職業用刺繍ミシン/クロムメッキ professional embroidery/chrome plating 职业用刺绣缝纫机/镀铬	A : 2.02 D : 33.90 N : 12.50-11.70	9 10 11 12 14 65 70 75 80 90
EL×705			 小型ロックミシン/カバーステッチ overlock/cover stitch 小型包缝机/绷缝机	A : 2.02 D : 33.90 N : 11.50	11 12 14 75 80 90
BL×1			 ベビーロック babylock 包缝	A : 1.63 D : 33.80 N : 13.50	9 10 11 12 14 16 65 70 75 80 90 100
HL×5			 小型ロックミシン/職業用ミシン overlock/professional 小型包缝机/职业用缝纫机	A : 2.00 D : 33.90 N : 12.50	9 10 11 12 14 16 18 20 65 70 75 80 90 100 110 125
DC×1F			 ベビーロック/DC×1の平取りえぐり側 babylock/flat shank at scarf, DC×1 包缝/DC×1的平面针针冠侧	A : 2.02 D : 28.60 N : 10.00	9 11 12 14 16 18 65 75 80 90 100 110
DC-C87			 ベビーロック/DC×1KNの平取りえぐり側 babylock/flat shank at scarf, DC×1KN 包缝/DC×1KN的平面针针冠侧	A : 2.02 D : 28.60 N : 10.00	9 10 11 12 14 65 70 75 80 90

公式サイト

Corporate Website

公式网站



JP



EN



CN



カタログ / リーフレット
Catalogue/brochure
产品目录 · 宣传册



縫製トラブル相談(ミシン針要因)
Sewing Trouble Consultant -
Needle Related Factors
缝制问题咨询 (缝纫机针原因)



手順 Procedure 流程

1. 縫製トラブル相談(ミシン針要因)受付用紙へ記入
Fill out the inquiry form
填写缝制问题咨询 (缝纫机针原因) 受理表
2. 提出資料の準備(トラブル生地、テスト用生地1×1m、副資材)
Prepare materials to submit
(fabric with trouble, 1×1m fabric scraps & sub materials)
准备提出资料 (发生问题的样品、试验用面料 1×1m、辅料)

3. 上記1、2を弊社グループ・弊社代理店へ送付
*英語・中国語版の受付用紙は営業担当へお問い合わせください
*ORGAN NEEDLE TECHNICAL LINKからも問合せ可能です
Submit 1 & 2 to our group or distributor.
*Please contact us for English/Chinese forms.
*Inquiry also available on ORGAN NEEDLE TECHNICAL LINK

请将上述 1、2提供给我们分公司・我公司代理店
*需要英语·中文受理表的话, 请和我公司营业担当联系
*也可以通过ORGAN NEEDLE TECHNICAL LINK进行联系

会員制 縫製技術情報サイト

Technical Information Membership Site for Industrial Sewing

会员制 缝制技术信息网站



JP



EN



CN

CONTENTS



トラブル解決
TROUBLESHOOTING
缝制问题解决



針と糸
NEEDLES & THREAD
针和线



縫製事例紹介
SEWING CASES
缝制事例介绍



動画ライブラリー
VIDEO LIBRARY
动画馆



技術情報
TECHNICAL RESOURCES
技术信息



ミシン針検索
NEEDLE SEARCH
缝纫机针检索

家庭用ミシン針専用サイト

(日本語表記のみ)

Art Stitch Room

アートステッチルーム



索引 / INDEX / 索引

記 SYSTEM 号 记	ページ PAGE 页
BL×1	20
CP×1	12
CP×12	12
CP×12J	12
CP×17	12
CP×170	12
CP×1J	12
CP×2	12
CP×200	12
DA×1	7
DA×1KN	7
DB×1	7
DB×1++	7
DB×1HS	7
DB×1KK	7
DB×1KN	7
DB×1KNLE	7
DB×1NS	7
DB×1-NY2	7
DB×1SF	7
DB×287WKH	7
DB×7ST	11
DB×95	7
DB×9ST	11
DB×A20	7
DB×F17	10
DB×F2	10
DB×K5	11
DB×K5KK	11
DB×K5-NY	11
DB×K5Z1	11
DB×K5Z1-NY	11
DB×K5Z2-NY	11
DB-F42	10
DC×1	17
DC×1F	20
DC×1KN	17
DC×1NS	17
DC×1SF	17
DC×27	17
DC×27LE	17
DC-C87	20
DC-N17	17
DC-N25	17
DC-N25SF	18
DI×3	7
DM×13	18
DM×13KN	18
DO×5	19
DO×558	19

記 SYSTEM 号 记	ページ PAGE 页
DO×558-NY2	19
DO×5-NY	19
DP×1	13
DP×134D	10
DP×134DIA	10
DP×134LL	10
DP×134LR	10
DP×134P	10
DP×134S	10
DP×134-SK	13
DP×17	7
DP×17++	7
DP×17D	9
DP×17DIA	9
DP×17HS	8
DP×17KK	13
DP×17KK2	13
DP×17LL	9
DP×17LR.	9
DP×17NS	8
DP×17P	9
DP×17RS	8
DP×17S.	9
DP×17SF	8
DP×17-SK	8
DP×17TQ.	9
DP×35D.	10
DP×35DIA	10
DP×35LL.	9
DP×35LR.	9
DP×35P.	9
DP×35R	8
DP×35R++	8
DP×35R-SK	8
DP×35S.	9
DP×438	13
DP×438KK	13
DP×5	12
DP×5++	12
DP×58	13
DP×5KN	12
DP×5NS	12
DP×5SF	12
DP×F22	10
DP-C119-NY2	8
DP-C126-NY2	8
DP-C80	8
DP-C80-NY2	8
DP-N29	8
DP-N45	8

記 SYSTEM 号 记	ページ PAGE 页
DV×1	15
DV×43	15
DV×57	15
DV×57LE	15
DV×57LE-NY2	15
DV×57-NY2	15
DV×59	15
DV×600	15
DV×63	15
DV×G9	15
DV-C65	16
EB×750	13
EB×755	13
EB×755NS	13
EL×705	20
FL×118A	16
FL×118GBS	16
FL×118GCS	16
FL×118GCS-NY2	17
FL×118GCSSF	17
FL×118KK	17
FL×118-SK	17
FLG-1	17
FLG-8	17
HA×1	20
HA×130EBBR	20
HA×1BR	20
HA×1DE	20
HA×1EB	20
HA×1GT	20
HA×1LL	20
HA×1QU	20
HA×1SP	20
HL×5	20
LW×1T	14
LW×251EU	14
LW×2T	14
LW×3T	14
LW×4T	14
LW×5T	14
LW×6T	14
LW-C5	14
MR-R9	18
MT×190	14
MT×190NS	14
PF×134KK	13
PF×134KKD	10
PF×134KKCLR	10
PF×134KKPCL	10
PF×134PCL	10

記 SYSTEM 号 记	ページ PAGE 页
PF×134PCR	10
PF×134VR	10
PH×1	11
PH×1SM	12
PH-C70	11
SG×1906	13
SG×1963	13
SG×1965	13
SM×1014A	16
SM×1014B	16
SM×1014H	16
SM×332EXTLG	19
SM×332EXTLG-NY	19
SM×332LG	19
SM×332SUPLG	19
TF×2	11
TF×2LR	11
TF×4	11
TF×6	11
TF×F8	11
TQ×1	19
TQ×3	19
TQ×7	19
TQ×7KK	19
TQ×9	19
TV×1	16
TV×3	16
TV×5	16
TV×5HS	16
TV×5-SK	16
TV×64	16
TV×7	16
TV×7HS	16
UN×154	18
UN-R12	18
UN-R7	18
UO×113GS	16
UO×113GS-NY2	16
UO×154	18
UY×121GBS	16
UY×128FL	15
UY×128GAS	15
UY×128GAS++	15
UY×128GASKN	15
UY×128GAS-SK	15
UY×128KK	15
UY×128KK-KN	15
UY×154GAS	18
UY×154GCS	18



ORGAN NEEDLE CO., LTD.

販売ネットワーク/SALES NETWORK/销售网络

オルガン針株式会社

〒386-1436 長野県上田市前山1番地
Tel:0268-35-3611 Fax:0268-38-3590
E-mail: sales-dptj@organ-ndl.co.jp

ORGAN NEEDLE CO., LTD.

1Maeyama, Ueda-shi, Nagano-ken 386-1436, Japan
Tel:+81-268-38-3363 Fax:+81-268-38-3590
E-mail: sales-dpt@organ-ndl.co.jp

■東京営業所

〒110-0015 東京都台東区東上野3-16-1オルガンビル
Tel:03-3833-1081 Fax:03-3835-7848
E-mail: tokyo@organ-ndl.co.jp

Tokyo Office

Organ Bldg., 3-16-1 Higashiueno, Taito-ku,
Tokyo 110-0015, Japan
Tel:+81-3-3833-1081 Fax:+81-3-3835-7848
E-mail: tokyo@organ-ndl.co.jp

■大阪営業所

〒540-0012 大阪府大阪市中央区谷町1-4-2オルガンビル
Tel:06-6941-9735 Fax:06-6943-6782
E-mail: osaka@organ-ndl.co.jp

Osaka Office

Organ Bldg.,1-4-2 Tanimachi, Chuo-ku, Osaka-shi,
Osaka 540-0012, Japan
Tel:+81-6-6941-9735 Fax:+81-6-6943-6782
E-mail: osaka@organ-ndl.co.jp

风琴针业有限公司

香港香港仔黄竹坑道26号建德工业大厦15字楼
Tel:+852-2552-8262 Fax:+852-2873-6037

ORGAN NEEDLE CO., LTD.

Kin Teck Industrial Bldg., 15th Floor,
26 Wong Chuk Hang Road, Aberdeen,
P. R. O. C. Special Administration Region, Hong Kong
Tel:+852-2552-8262 Fax:+852-2873-6037

奥罗冈针业(重庆)有限公司上海分公司

邮编200040
中国上海市北京西路1271号国旅大厦1001室
Tel: +86-21-6279-3330 Fax: +86-21-6279-1109

ORGAN NEEDLE(CHONGQING) CO., LTD.

SHANGHAI BRANCH

Room No.1001, Guolv Bldg., No.1271 Beijing West Road,
Shanghai, China 200040
Tel: +86-21-6279-3330 Fax: +86-21-6279-1109

台湾风琴针贸易股份有限公司

台湾台北市承德路三段30号3F
Tel:+886-2-2585-5190/5193 Fax:+886-2-2585-5182

TAIWAN ORGAN NEEDLE TRADING CO., LTD.

3F., No.30, Sec.3, Chengde Rd., Datong Dist., Taipei City,
Taiwan
Tel:+886-2-2585-5190/5193 Fax:+886-2-2585-5182

ORGAN NEEDLE (SINGAPORE) CO. PTE LTD.

No.190, Middle Road, #13-05 Fortune Centre,
Singapore 188979
Tel:+65-6339-3581/3588 Fax:+65-6339-5550

风琴针业(新加坡)私人有限公司

No.190, Middle Road, #13-05 Fortune Centre,
Singapore 188979
Tel:+65-6339-3581/3588 Fax:+65-6339-5550

ORGAN NEEDLE EUROPE GmbH

Kesselsgracht 7, D-52146 Würselen, Germany
Tel:+49 2405 4992 120 Fax:+49 2405 4992 125

ORGAN NEEDLE EUROPE GmbH

Kesselsgracht 7, D - 52146 Wuerselen, Germany
Tel:+49 2405 4992 120 Fax:+49 2405 4992 125

CÔNG TY TNHH THƯƠNG MẠI KIM MAY ORGAN VIỆT NAM

Tầng 7, Số 400 Đường Nguyễn Thị Thập,
Phường Tân Quy. Quận 7, Thành phố Hồ Chí Minh
Tel:+84-28-3771-8025/8026 Fax:+84-28-3771-8027

ORGAN NEEDLE TRADING VIETNAM CO., LTD.

7F., 400 Nguyen Thi Thap Str., Tan Quy Ward, District 7,
Ho Chi Minh City, Vietnam
Tel:+84-28-3771-8025/8026 Fax:+84-28-3771-8027